

# impala

vertical blind system  
components book



Copyright © 2005 Eclipse Blind Systems. All rights reserved. This manual may not be copied, photocopied, reproduced, translated, or converted to any electronic or machine-readable form in whole or in part without prior written approval of Eclipse Blind Systems.  
Document Number — MSL8004

**Trademarks**

Eclipse is a registered trademark of Eclipse Blind Systems.

**Acknowledgments**

-

**Document History**

Issue 8 — May 2006  
Issue 7 — January 2006  
Issue 6 — December 2005  
Issue 5 — October 2005  
Issue 4 — June 2005  
Issue 3 — June 2005  
Issue 2 — May 2005  
Issue 1 — October 2004  
Preview Edition — August 2004

# Contents

<b>page 4</b>	<b>Parts List</b>
<b>page 5</b>	<b>General Specification</b>
<b>page 7</b>	<b>Exploded View</b> single draw blind mono control blind
<b>page 9</b>	<b>Components</b>
<b>page 17</b>	<b>Child Safety Devices</b>
<b>page 18</b>	<b>Impala Tooling</b> fabric vane production tooling workstation for vertical tooling PVC vane tooling Aquatek tooling tooling spares
<b>page 23</b>	<b>Bill of Materials</b> single draw blind split draw blind mono control blind
<b>page 25</b>	<b>Tooling Guide</b>
<b>page 29</b>	<b>Index</b>
<b>page 31</b>	<b>Document History</b>

# Parts List

- page 11 Flat adjustable bracket, right angled adjustable bracket, universal extension bracket, universal face fix bracket, face fix bracket, shallow face fix bracket
- page 12 Rigid top fix bracket, snap-in top fix bracket, woodscrew, wall plug, masonry drill bit, headrail, endcap set, mono control endcap set
- page 13 Distance plate, expansion grommet, incline traveller dropper, louvre hanger, sheer clip, velcro loops, louvre weight
- page 14 Shaft support, pull cord traveller, end traveller set, Cobra end traveller set, traveller stop, traveller body
- page 15 Spacer link, travellers
- page 16 Cobra travellers, cord weight, stabilising chain
- page 17 Operating chain, chain connector, pull cord, wand gearbox, control rod
- page 18 Handle, open ball, fascia, corner connector, fascia clip, hot melt adhesive, polythene, silicone aerosol, work cards
- page 19 Vane saver, control chain safety clip, cord cleat pack, cord stop ring, breakaway tassel
- page 20 Rail assembly jig set, threading needle, traveller alignment tool, operating chain pliers, electric cord cutter, cut punch & crease machine, vertical blind workstation, louvre fabric clamp, flat tape measure, vane manual slitter, hot melt applicator
- page 21 Impala workstation, free standing materials dispenser, bench mount materials dispenser, shelves, components rack, PVC punch, self standing unit for PVC punch, PVC vane measuring kit, PVC/Aquatek bench, oval top notch punch
- page 22 Corner rounder, bench mount fabric dispenser, hot knife cutter, blade, gas fabric, vane measuring kit/clamp
- page 23 LPT head, hanger hole punch, hanger punch base plate, compression pad, compression pad screw, ball nose driver, spring pin, rotary cutter, brass plunger, plunger spring, clamp release unit
- page 24 Neoprene strip, main operating handle, head cutting edge, brass hinge, clamp crossbar, conveyor & trough, trough, flapper unit, flapper unit side, conveyor belt, individual dog, dowel for main handle, conveyor belt upright

# General Specification

## General specification

The Impala Vertical Track System is the result of many years of Research and Technical Development producing a product suited for both the contract and domestic markets. It has been designed for maximum performance and minimum maintenance, allowing consistent operation even with the rigors and occasional abuse of commercial installations.

It offers a rigid self-aligning facility, which means the vanes cannot be easily knocked out of line, but should it occur, can easily and quickly be corrected by an operation of the chain.

Textile vertical vanes are available in 89mm and 127mm widths. The vanes are suspended from the track with a specially designed carrier and hook, and can be traversed to either side or both as required. They are specially weighted at their base and securely interconnected by a twin chain system using nickel-plated brass or plastic, ball chain as required.

## Component specification headrail

The Impala headrail is extruded in aluminium alloy 6063TF and conforms to BS 1474. The contoured profile provides excellent rigidity and strength conforming to BS1615 AA5. It can accommodate windows up to 5 metres wide. The 44mm width and 26mm height add further to the strength, making the headrail suitable for virtually every installation.

## Tilt shaft

Like the headrail, the tilt rod is extruded in aluminium alloy 6063 TF to BS 1474. It is designed as a drive shaft between the control end cap and the traveller gear. It is trefoiled to engage securely in the splines of the traveler ensuring a smooth rotation through 216°.

## Travellers

Moulded in co-polymers, the traveller forms the basis of the Impala Vertical Track System. It features a self-aligning ratchet system ensuring the vanes cannot easily be knocked out of line.

Offering carriers with 216° rotational ability gives maximum closure of the vanes ensuring effective control of solar glare and heat gain.

The hook is moulded in Nylon 6 Distrupol. It has been designed to accommodate both textile and rigid PVC vanes. It has an aesthetically pleasing shape and also ensures the hanger is held secure, thus increasing the stability of the vanes. The hook is centrally located within the track which means headrails can be butt-jointed without the need to specify "handing" for the controls.

The travellers are connected by co-polymer moulded spacer links ensuring an overlap of each vertical vane of not less than 11mm and complete closure of the vanes.

The hanger, moulded in impact-modified nylon 6, incorporates a unique dual positioning. This allows for any on-site adjustment to the height of the vanes to accommodate uneven or undulating sills. This also ensures minimum gap between headrail and vanes.

### **Controls**

The vanes are rotated by means of No. 8 nickel plated brass or plastic ball chain passing over the sprocket gear mouldings within the drive mechanism.

Traversing the blind is actioned by 2.2mm diameter reinforced polynylon cord passing through the control end cap and connecting to the leading traveller. Tension is retained in the pull cord by an ABS moulded cord weight or a co-polymer moulded cord tidy, which can be recess mounted, holding the cord under tension without inhibiting operation.

### **Impala planetary-gear end cap**

The Impala planetary-gear end cap has been developed to overcome the limitations of conventional end cap componentry and gives the smoothest rotation even on the largest blinds.

The body of the end cap is moulded in glass fibre filled Nylon 6 in a selection of colours to complement the headrails and, having no visible working parts, gives additional aesthetic appeal.

The gearing, which is moulded in silicon impregnated polyester, incorporates a 4:1 reduction ratio meaning smoother control and rotation. The special silicone impregnation of the polymers gives smooth quiet operation to the gears.

### **Fixing specification**

The system comes with a variety of fixing options: rigid top fix and face fix brackets are readily available. These are available in epoxy-coated white and brown making them compatible with most contemporary décor. A third option is a tempered spring steel top fix bracket for even speedier installation.

Special multi-purpose extension brackets can be used for specific or awkward installation. When used in conjunction with the top fix brackets the 'throw' is increased by up to 70mm. When fixing into timber 18mm No. 8 screws are recommended. When fixing into plaster or concrete 31mm No. 8 screws together with rawlplugs are the secure option. If, however the fixing is being made into cavity walls, the brackets can be attached using cavity plugs and 31mm No. 8 screws.

Before fixing to uPVC, consult your window manufacturer.

### **Blind width Vs number of fixing brackets**

Below 1350mm	2
1350mm to 2100mm	3
2100mm to 2100mm	4
2100mm to 4500mm	5
Above 4500mm	6

Where there is a long drop additional brackets are recommended.

# Exploded View

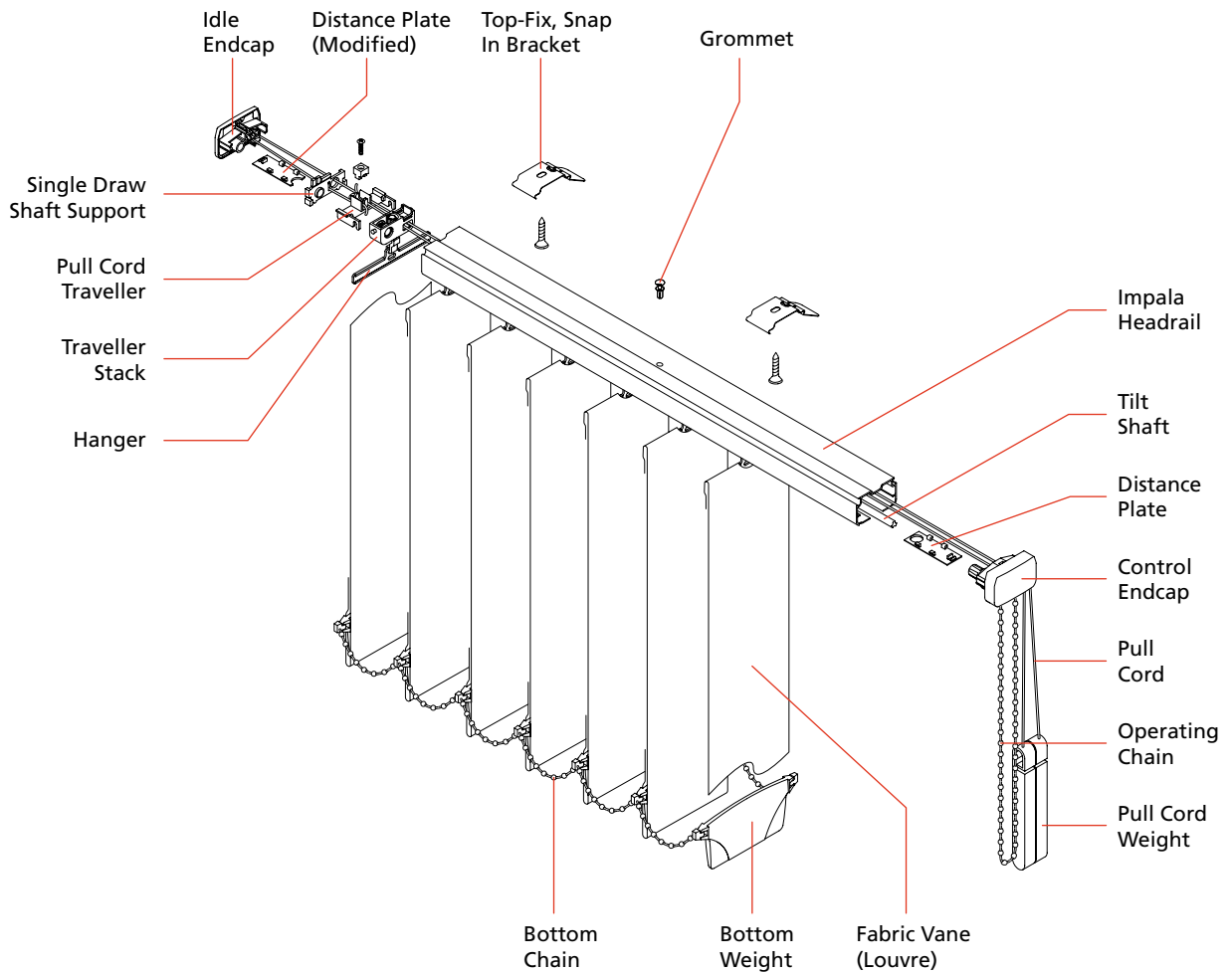

Exploded view of single draw Impala blind with stack of standard build travellers at the control end. Blind operated by cord & chain.

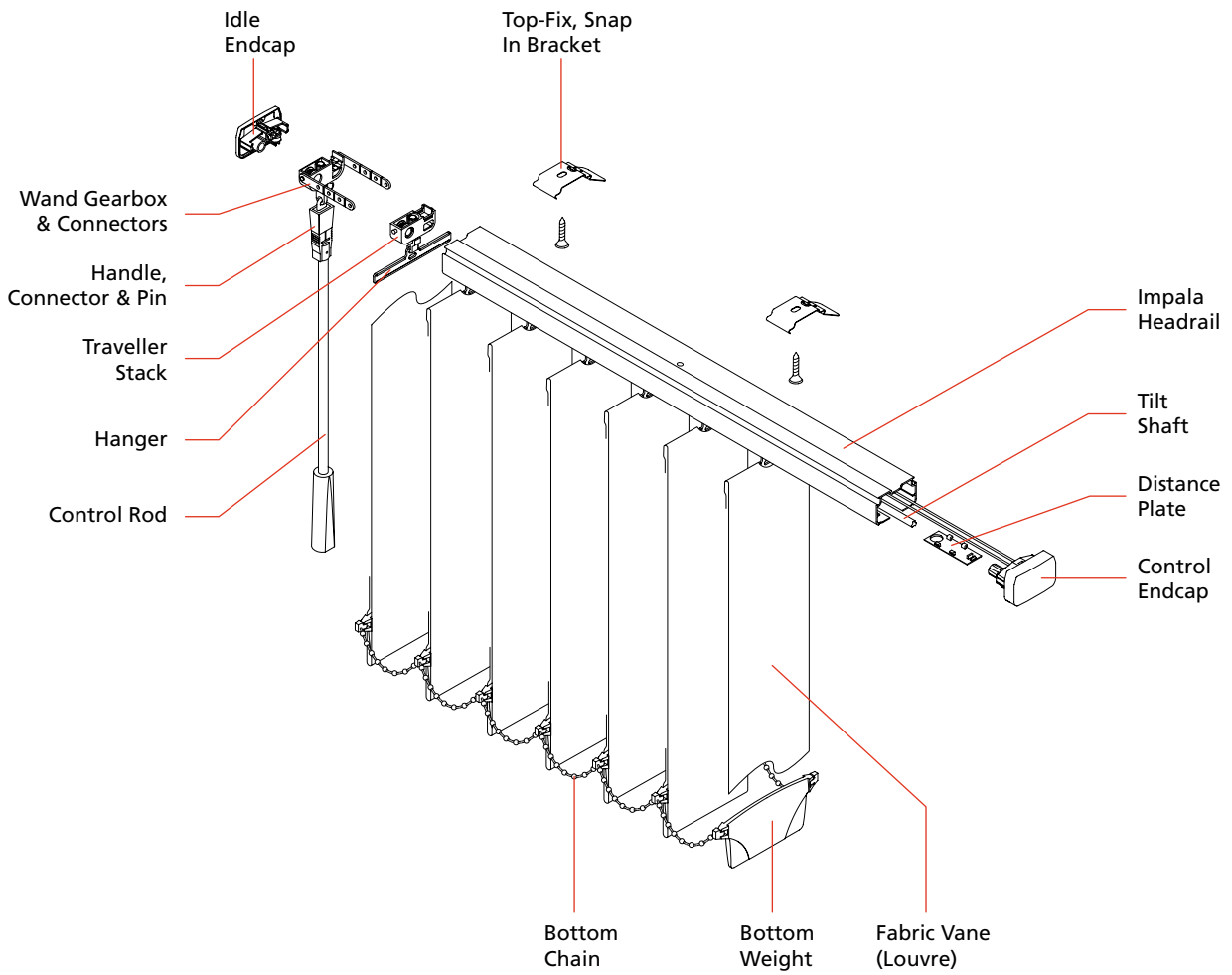

Exploded view of single draw Impala Mono Control blind with stack of standard build travellers at the control end. Blind operated by wand.

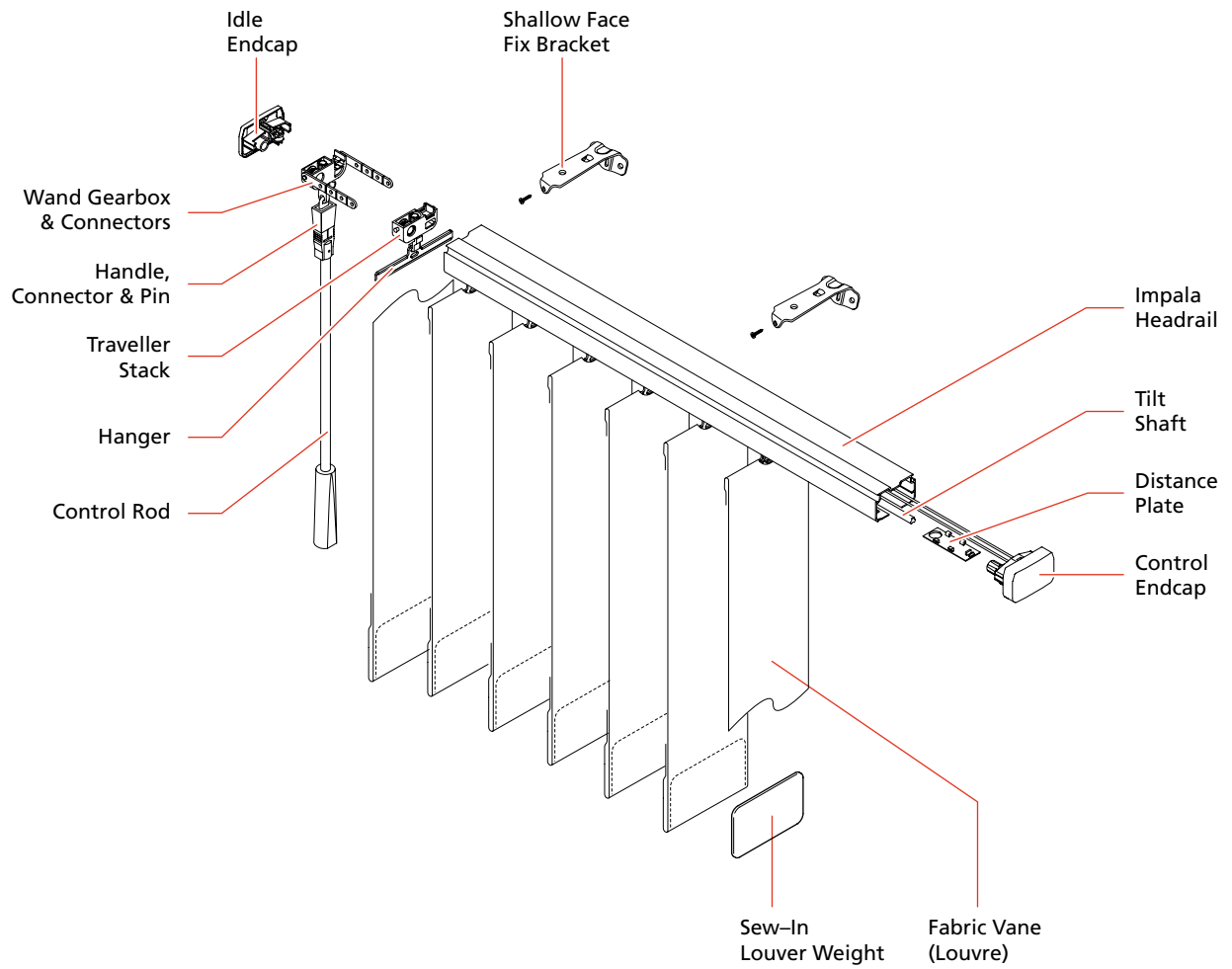

Exploded view of single draw Impala Mono Control blind with stack of standard build travellers at the control end and sew-in louver weights. Blind operated by wand.

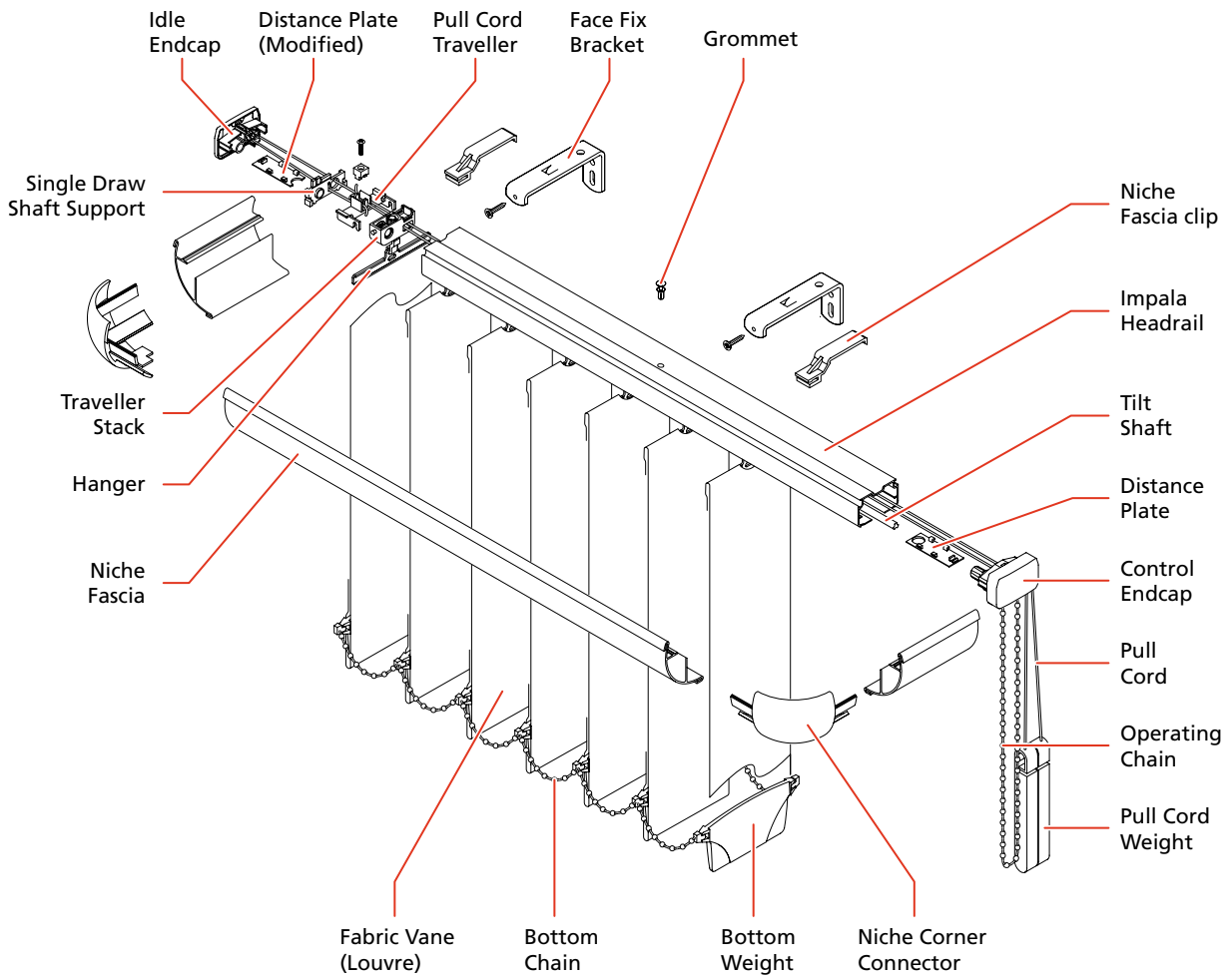

Exploded view of outside recess single draw Impala blind with Niche fascia. Blind operated by cord & chain.

# Components

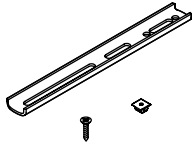

## Installation Bracket, Adjustable

Flat  
top fix with 63mm to 173mm throw  
Mild steel, epoxy coating

LH432 white 100

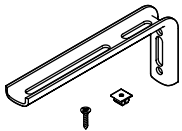

## Installation Bracket, Adjustable

Right angled  
face fix with 58mm to 128mm throw  
Mild steel, epoxy coating

LH431 white 100

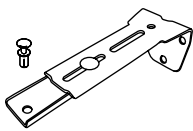

## Installation Bracket, Adjustable

Universal extension  
face fix with 108mm to 137mm throw  
Mild steel, epoxy coating

LH433 white 50

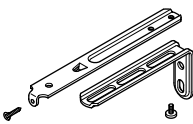

## Installation Bracket, Adjustable

Extension  
face fix with 130mm to 195mm throw  
Mild steel

LH126 nickel plated 100  
LH127 white 100

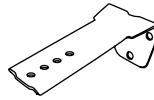

## Installation Bracket, Adjustable

Universal face fix  
for 89mm (3½") vanes, 36mm to 66mm throw  
Mild steel, epoxy coating

LH438 white 100

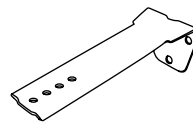

## Installation Bracket, Adjustable

Universal face fix  
for 127mm (5") vanes, 66mm to 96mm throw  
Mild steel, epoxy coating

LH439 white 100

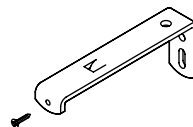

## Installation Bracket

Face fix  
for 127mm (5") vanes, 74mm throw  
Mild steel

LH111 platinum 100  
LH113 white 100  
LH114 brown 100

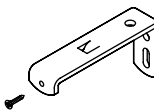

## Installation Bracket

Face fix  
for 89mm (3½") vanes, 55mm throw  
Mild steel

LH116 platinum 100  
LH118 white 100  
LH119 brown 100

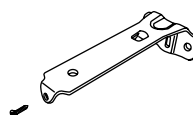

## Installation Bracket

Shallow face fix  
for 127mm (5") vanes, 74mm throw  
Mild steel

LH120 platinum 100  
LH121 white 100  
LH122 brown 100

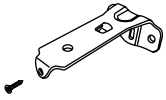
**Installation Bracket**

Shallow face fix  
 for 89mm (3½") vanes, 55mm  
 throw  
 Mild steel

LH123	platinum	100
LH124	white	100
LH125	brown	100

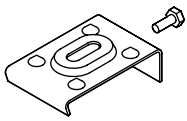
**Installation Bracket**

Rigid top fix  
 use panhead fixing screw, not  
 countersunk  
 Mild steel

LH101	platinum	300
LH103	white	300

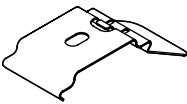
**Installation Bracket**

Snap-in top fix  
 use panhead fixing screw, not  
 countersunk  
 Mild steel

LH106	platinum	300
LH108	white	300
LH109	brown	300

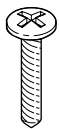
**Woodscrew**

Pozidriv  
 for bracket fixing  
 Mild steel

MP024	No.6×12mm	1000
MP017	No.6×19mm	1000
MP018	No.6×32mm	1000
MP021	No.8×19mm	1000
MP022	No.8×25mm	1000
MP023	No.8×32mm	1000

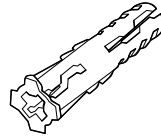
**Wall Plug**

suits No.6, No.8 & No.10 woodscrew  
 Plastic

MP026	natural	1000
-------	---------	------

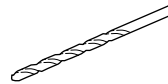
**Masonry Drill Bit**

Ø5.5mm  
 for rotary or hammer drill  
 Hardened steel

MP028	natural	20
-------	---------	----

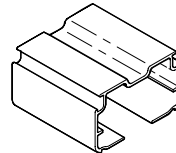
**Headrail**

Low profile, 45mm × 26mm  
 includes tiltshaft  
 Aluminium alloy, epoxy coating

LH501	platinum	80m
LH502	brown	80m
LH503	white	80m

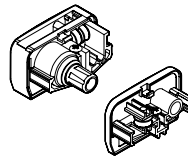
**Endcap Set**

Control & idle endcaps  
 Nylon 6

LH509	brown	50
LH510	white	50
LH520	platinum	50

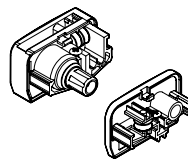
**Mono Control Endcap Set**

Control & idle endcaps  
 direct drive feature  
 Nylon 6

LH519	white	50
-------	-------	----

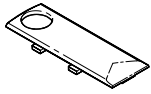

**Distance Plate**

Positions traveller  
for 127mm (5") vanes  
Nylon 6

LH512	white	500
LH514	brown	500

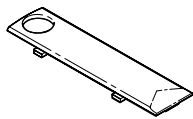

**Distance Plate**

Positions traveller  
for 89mm (3½") vanes  
Nylon 6

LH513	white	500
LH515	brown	500



**Expansion Grommet**

Positions shaft support  
included with LH506 (single draw  
shaft support)  
Nylon

LH507	white	1000
-------	-------	------

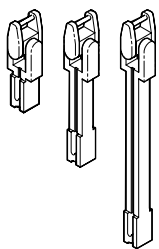

**Incline Traveller Dropper**

Prevents vanes fouling on  
headrail

for sloping headrail blinds  
Acetal, white (LH402 beige)

LH402	25mm drop	200
LH403	25mm drop	200
LH407	48mm drop	200
LH412	82mm drop	200

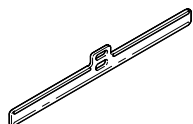

**Louvre Hanger**

Two position  
for 127mm (5") vanes  
Plastic

LH602	beige opaque	1000
LH6025	white opaque	1000
LH619	clear transparent	1000

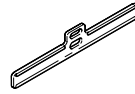

**Louvre Hanger**

Two position  
for 89mm (3½") vanes  
Acetal

LH604	beige opaque	1000
LH6045	white opaque	1000
LH620	clear transparent	1000

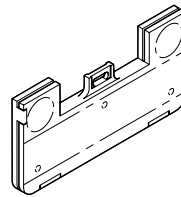

**Sheer Clip**

attaches PVC vane to hanger, used  
with SoftSheer blinds  
Acetal

LH695	white	100
-------	-------	-----

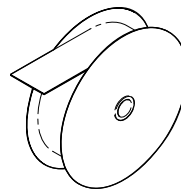

**Velcro Loops**

attaches sheer fabric to clip

LH696	natural	25m
-------	---------	-----

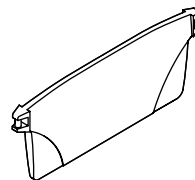

**Louvre Weight**

45g min. weight  
for 127mm (5") vanes  
Polypropylene

LH607	white	400
LH608	beige	400

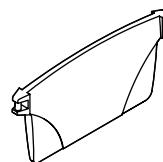

**Louvre Weight**

45g min. weight  
for 89mm (3½") vanes  
Polypropylene

LH609	white	500
LH610	beige	500

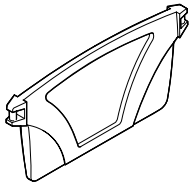

**Louvre Weight**

Standard, 30g min. weight, white

Polypropylene

LH616	127mm (5")	400
LH615	89mm (3½")	500

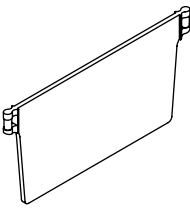

**Louvre Weight**

Economy, 38g min. weight, white

Polypropylene

LH807	127mm (5")	400
LH809	89mm (3½")	400

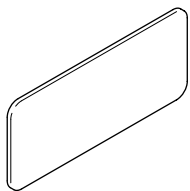

**Louvre Weight**

Sew-In, metal, natural finish  
*use when bottom weight needs to be sewn into the vane on all sides*  
Steel, 2mm thick

LH614	127mm (5"), 60g	250
LH613	89mm (3½"), 35g	300

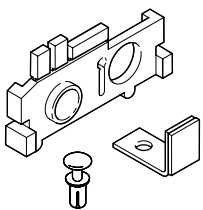

**Shaft Support**

Single draw

*includes LH507 (expansion grommet), metal catch plate and velcro pads*

Acetal

LH506	white	50
-------	-------	----

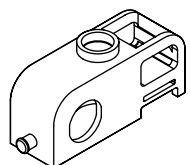

**Shaft Support**

Split draw

Acetal

LH508	white	100
-------	-------	-----

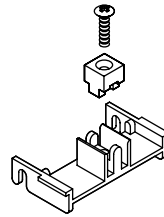

**Pull Cord Traveller**

*Attaches to traveller stack*

Acetal

LH077	beige	100
LH078	white	100

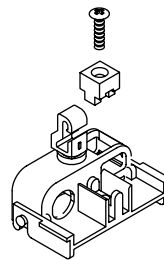

**End Traveller Set**

Pre-assembled pull cord traveller and traveller body

Acetal

LH589	white	100
-------	-------	-----

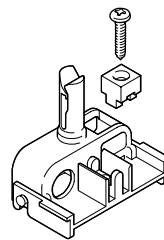

**Cobra End Traveller Set**

Pre-assembled pull cord traveller and traveller body

Acetal

LH587	white	100
-------	-------	-----

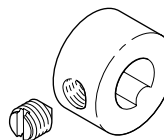

**Traveller Stop**

Adjustable

Nylon 6

LH645	Platinum	200
LH646	Beige	200

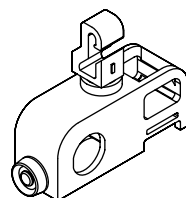

**Traveller Body**

Without spacer link

Aceta, white body

LH511	White hooks	500
LH900	Clear hooks	500

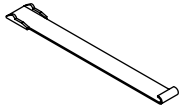

**Spacer Link**

Acetal

LH378	3F/66mm	500
LH379	3E/68mm	500
LH380	3D/70mm	500
LH381	3C/72mm	500
LH382	3B/74mm	500
LH384	3A/76mm	500
LH386	5H/96mm	500
LH387	5G/99mm	500
LH388	5F/102mm	500
LH389	5E/105mm	500
LH390	5D/107.5mm	500
LH391	5C/110mm	500
LH392	5B/112.5mm	500
LH394	5A/115mm	500

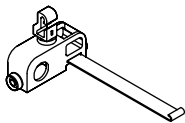

**Travellers**

89mm (3½"), white, standard

*assembled in bunches of 10s*

Acetal, white opaque hooks

LH539	3D/70mm	500
LH540	3C/72mm	500
LH541	3B/74mm	500
LH543	3A/76mm	500
LH591	3E/68mm	500
LH592	3F/66mm	500

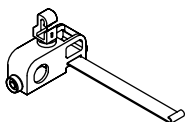

**Travellers**

89mm (3½"), white, standard

*assembled in bunches of 10s*

Acetal, clear transparent hooks

LH901	3A/76mm	500
LH902	3B/74mm	500
LH903	3C/72mm	500
LH904	3D/70mm	500
LH905	3E/68mm	500
LH906	3F/66mm	500

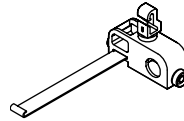

**Travellers**

89mm (3½"), white, reverse

*assembled in bunches of 10s*

Acetal, white opaque hooks

LH544	3D/76mm	500
LH545	3C/74mm	500
LH546	3B/72mm	500
LH548	3A/70mm	500
LH593	3E/68mm	500
LH594	3F/66mm	500

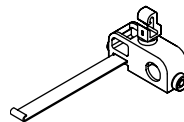

**Travellers**

89mm (3½"), white, reverse

*assembled in bunches of 10s*

Acetal, clear transparent hooks

LH907	3A/76mm	500
LH908	3B/74mm	500
LH909	3C/72mm	500
LH910	3D/70mm	500
LH911	3E/68mm	500
LH912	3F/66mm	500

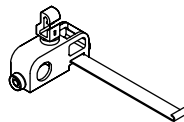

**Travellers**

127mm (5"), white, standard

*assembled in bunches of 10s*

Acetal, white opaque hooks

LH549	5D/107.5mm	500
LH550	5C/110mm	500
LH551	5B/112.5mm	500
LH553	5A/115mm	500
LH595	5E/105mm	500
LH596	5F/102mm	500

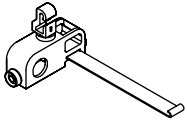
**Travellers**

127mm (5"), white, standard  
*assembled in bunches of 10s*  
 Acetal, clear transparent hooks

LH913	5A/115mm	500
LH914	5B/112.5mm	500
LH915	5C/110mm	500
LH916	5D/107.5mm	500
LH917	5E/105mm	500
LH918	5F/102mm	500

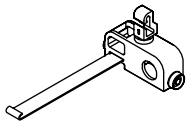
**Travellers**

127mm (5"), white, reverse  
*assembled in bunches of 10s*  
 Acetal, white opaque hooks

LH554	5D/107.5mm	500
LH555	5C/110mm	500
LH556	5B/112.5mm	500
LH558	5A/115mm	500
LH597	5E/105mm	500
LH598	5F/102mm	500

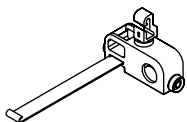
**Travellers**

127mm (5"), white, reverse  
*assembled in bunches of 10s*  
 Acetal, clear transparent hooks

LH919	5A/115mm	500
LH920	5B/112.5mm	500
LH921	5C/110mm	500
LH922	5D/107.5mm	500
LH923	5E/105mm	500
LH924	5F/102mm	500

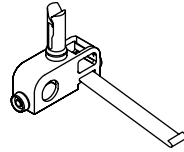
**Cobra Travellers**

89mm (3½"), white, standard  
*assembled in bunches of 10s*  
 Acetal, clear transparent hook

LH570	3A/76mm	500
LH571	3C/72mm	500
LH572	3E/68mm	500
LH573	3B/74mm	500
LH574	3D/70mm	500
LH575	3F/66mm	500

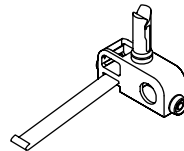
**Cobra Travellers**

89mm (3½"), white, reverse  
*assembled in bunches of 10s*  
 Acetal, clear transparent hook

LH580	3A/76mm	500
LH581	3C/72mm	500
LH582	3E/68mm	500
LH583	3B/74mm	500
LH584	3D/70mm	500
LH585	3F/66mm	500

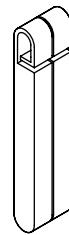
**Cord Weight**

Includes internal metal weight  
*Prevents cord from retreating into headrail*

LH451	platinum	100
LH452	beige	100
LH453	brown	100
LH454	white	100

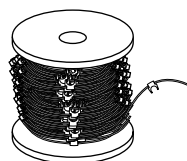
**Stabilising Chain**

*for 127mm (5") vanes*  
 Nickel plated brass balls, polyethylene clip

LH621	white	200m
LH622	beige	200m

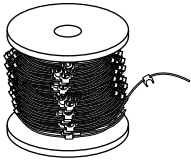

**Stabilising Chain**

*for 89mm (3½") vanes*  
Nickel plated brass balls, polyethylene clip

LH623	white	200m
LH624	beige	200m

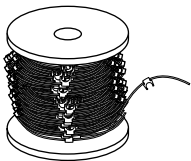

**Stabilising Chain**

*for 127mm (5") vanes*  
High density polyethylene clip

LH625	white	150m
LH626	beige	150m
LH629	grey	150m

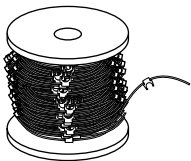

**Stabilising Chain**

*for 89mm (3½") vanes*  
High density polyethylene clip

LH627	white	125m
LH628	beige	125m
LH630	grey	125m

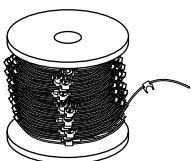

**Stabilising Chain**

*for economy louvre weight*  
High density polyethylene clip

LH825	127mm (5")	250m
LH827	89mm (3½")	250m

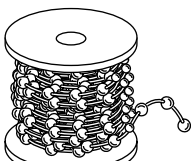

**Operating Chain**

No.8 balls, metal  
Nickel plated brass

LH632	natural	125m
-------	---------	------

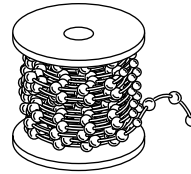

**Operating Chain**

No.8 balls, plastic  
High density polyethylene

RH349	white	150m
-------	-------	------

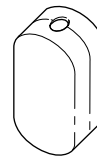

**Chain Connector**

*for joining plastic operating chain*  
Acetal

RH350	white	100
-------	-------	-----

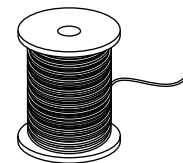

**Pull Cord**

*for traversing the vanes*  
Polyester

LH636	beige/br'n fleck	500m
LH637	white	500m
LH638	grey	500m
LH639	white/black fleck	500m

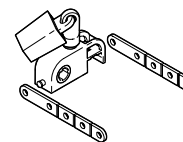

**Wand Gearbox**

Mono control system  
*includes connectors*  
Acetal

LH690	white	10
-------	-------	----



**Control Rod**

Mono control system  
*one connector, 1.22m long*  
Aluminium alloy

LH5182	white	10
--------	-------	----

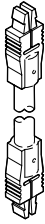

**Control Rod**  
Mono control system  
*two connectors, 2.44m long*  
Aluminium alloy  
LH5183 white 10

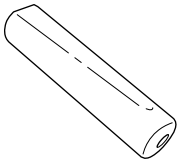

**Handle**  
Mono control system  
*for control rod*  
Polypropylene  
LH5185 white 10



**Open Ball**  
Mono control system  
Metal  
14233 Natural 1000

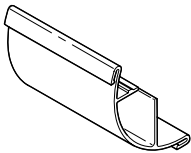

**Niche Fascia**  
Make the blind more attractive,  
hides the headrail and reduces  
the light gap  
*supplied in 4m lengths, 10*  
PVC  
LH740 clear 40m

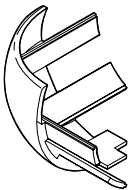

**Niche Corner Connector**  
Used on outside recess blinds,  
allows fascia to 'wrap-around'  
headrail  
ABS Polycarbonate  
LH746 white 20

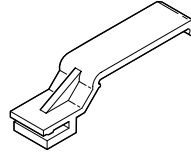

**Niche Fascia Clip**  
Connects the fascia to the  
headrail  
Polycarbonate  
LH749 clear 20



**Hot Melt Adhesive**  
Mini sticks  
*for use with TP102*  
Rubber/EVA thermoplastic  
LH647 natural 5kg

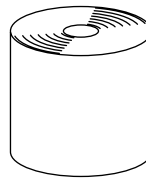

**Polythene**  
80µm thick  
*packing material to prevent  
damage or dirt*  
Low density PE  
MP101 100mm wide 420m  
MP102 152mm wide 560m  
MP103 178mm wide 480m  
MP104 229mm wide 380m

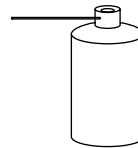

**Silicone Aerosol**  
Louvre glide  
*for lubricating inside headrail*  
LH642 natural 12

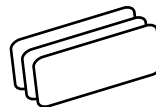

**Work Cards**  
Specification labels  
*for recording blind details*  
Paper  
MSL135 natural 500

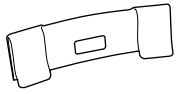

**Vane Saver (curved)**

Clips to top of PVC vane when hole has broken and can no longer be hung on hook  
SP531 white 1

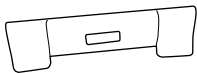

**Vane Saver (straight)**

Clips to top of PVC vane when hole has broken and can no longer be hung on hook  
SP532 white 1

# Child Safety Devices



**Control Chain Safety Clip**

Packed individually with fitting/warning instruction and screw

*Secures continuous loop*

Plastic

LH890 white 100pks

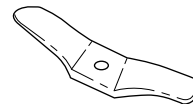

**Cord Cleat Pack**

Packed individually with 2 cleats, fitting/warning instruction, and 2 screws per packet

*Secures lift cord*

Plastic

VH645 clear 100pks

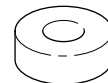

**Cord Stop Ring**

*Prevents pull cord being pulled back through blind*

Plastic

VH640 clear 1000



**Breakaway Tassel**

Suits cord up to Ø1.6mm

*Splits into 2 parts under pressure*

Plastic

MP006 clear 100

# Impala Tooling



## Rail Assembly Jig Set

Includes TP119

*an aid to assembling Impala blinds*

Metal, plastic

TP103 various 1



## Threading Needle

*for threading cord through traveller stack*

Steel core with nickel plated steel wrap

TP119 natural 1

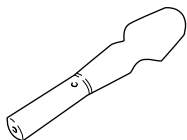

## Traveller Alignment Tool

Heavy duty

*Ratch the travellers into alignment by attaching to tiltshaft*

Steel

TP138 red 1

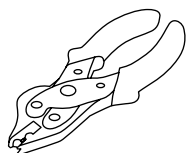

## Operating Chain Pliers

Suit No.8 ball

*for joining metal operating chain*

Mild steel

TP109 red 1

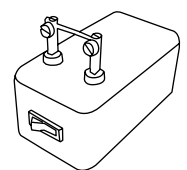

## Electric Cord Cutter

*for cutting and sealing cord*

Metal

TP032 natural 1

# Fabric Vane Production Tooling

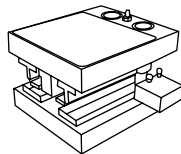

## Cut, Punch & Crease Machine

CPC press tool

*supplied boxed with TP117, SP802/SP803 and 2m Impala rail 2-off*

Metal

TP120 black 1

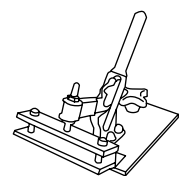

## Cut, Punch & Crease Machine

Louvre fabric clamp

Aluminium alloy

TP117 natural 1



## Flat Tape Measure

Tape measure, self-adhesive

Steel, yellow

SP802 Imperial 1

SP803 Metric 1

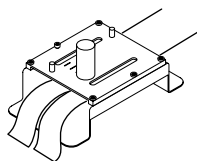

## Vane Manual Slitter

Cuts fabric for fascia system & 127mm to 89mm

Steel plated

TP168 natural 1



## Hot Melt Applicator

Plastic

TP102 red 1

## Workstation for Vertical Tooling

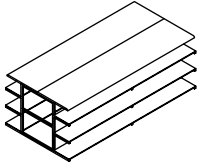

### Impala Workstation

(h)0.9m × (w)1.2m × (l)4.0m  
Mild steel frame, medium density  
fiberboard tops

TP333B red/grey 1

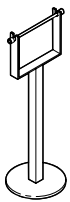

### Free Standing Materials Dispenser

Can be used with fabric reel,  
pull cord or operating chain  
Mild steel frame

TP343 red 1

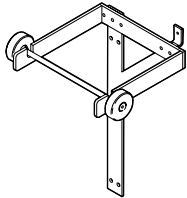

### Bench Mount Materials Dispenser

Can be used with fabric reel,  
pull cord or operating chain  
Mild steel frame

TP344 red 1

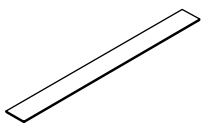

### Shelves

Option for Impala Workstation  
Steel

TP341 4.0m 1

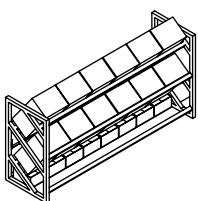

### Components Rack

Option for Impala Workstation  
Mild steel frame

TP148 red 1

## PVC Vane Tooling

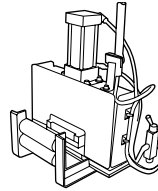

### PVC Punch (89mm vanes)

Pneumatic punch for 89mm  
PVC vanes

*Can be bench mounted or sits on*

TP162 natural 1

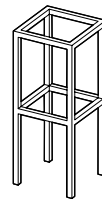

### Self Standing Unit for PVC Punch

*Additional support for TP162*

TP163 natural 1

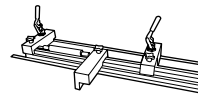

### PVC Vane Measuring Kit

*Mounts onto TP160*

TP161 natural 1

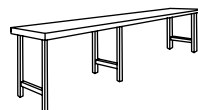

### PVC/Aquatek Bench

TP160 natural 1



### Oval Top Notch Punch

Hand tool

*produces oval hole in vane for  
mounting onto Impala hook*

Mild steel

TP131 natural 1

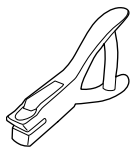

### Corner Rounder for PVC Vanes

Hand tool

*rounds covrner of vanes, removing sharp edge*

Mild steel

TP135 natural 1

## Aquatek Tooling

### Bench Mounted Fabric Dispenser

-  
-  
-

TP166 natural 1

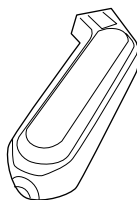

### Hot Knife Cutter

240v, hand held, requires blade TP143

*cuts and heat seals fabric, prevents fraying*

Metal, plastic

TP140 green 1

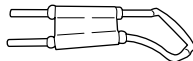

### Blade

*for TP140 only*

Metal

TP143 natural 1

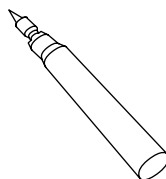

### Gas Fabric Cutter

*cuts and heat seals fabric, prevents fraying*

Metal, plastic

TP141 orange 1

### Vane Measuring Kit/ Clamp

-  
-

TP164 natural 1

# Tooling Spares

## Spares for TP101 (discontinued)

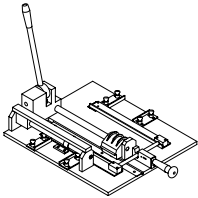

### LPT Head

Cuts, punches & creases fabric, suitable for Eclipse bottom weight and hanger

*spare for TP101*

SP501 natural 1



### Hanger Hole Punch

Produces 15.5mm x 12.7mm oval hole

*spare for LPT head*

Hardened steel

TP111 natural 1

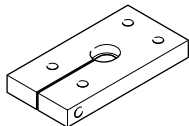

### Hanger Punch Base Plate

*spare for LPT head*

SP525 natural 1

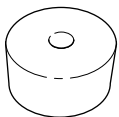

### Compression Pad

Presses fabric onto TP111

*spare for LPT head*

Nylon 66

TP112 natural 1



### Compression Pad with Metal Washer

For high volume production

*spare for LPT head*

Nylon 66, mild steel washer

TP112M natural 1

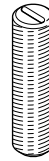

### Compression Pad Screw

*spare for LPT head*

SP506 natural 1

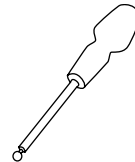

### Ball Nose Driver

*spare for LPT head*

SP507 natural 1

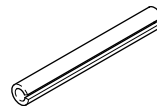

### Spring Pin

*spare for LPT head*

SP524 natural 1

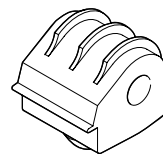

### Rotary Cutter

Includes round blade and plastic cover

*spare for LPT head*

SP503 natural 1



### Brass Plunger

*spare for LPT head*

SP504 natural 1

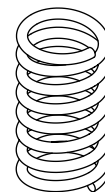

### Brass Plunger Spring

*spare for LPT head*

SP505 natural 1

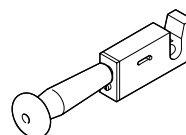

### Clamp Release Unit

*spare for LPT head*

SP513 natural 1

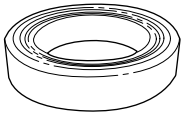

**Neoprene Strip**  
50mm wide x 1.0m long x 3mm  
thick, self-adhesive  
*spare for LPT head*  
SP514 natural 1



**Main Operating Handle**  
*spare for LPT head*  
SP515 natural 1

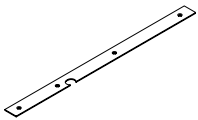

**Head Cutting Edge**  
*spare for LPT head*  
SP517 natural 1

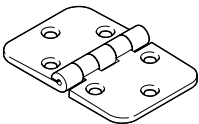

**Brass Hinge**  
*spare for LPT head*  
SP518 natural 1

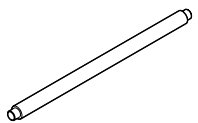

**Clamp Crossbar**  
*spare for LPT head*  
SP519 natural 1

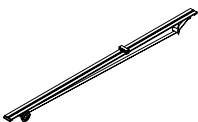

**Conveyor and Trough**  
SP502 natural 1

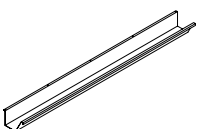

**Trough**  
Catches fabric alongside  
conveyor  
*Spare for TP120*  
SP508 natural 1

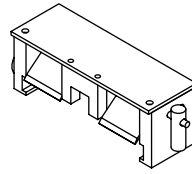

**Flapper Unit**  
Conveyor stop  
*Spare for SP502*  
SP509 natural 1

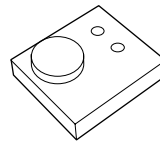

**Flapper Unit Side**  
Includes thumb screw  
*Spare for SP509*  
SP510 natural 1

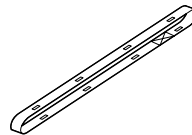

**Conveyor Belt**  
Includes 8 pre-attached dogs  
SP511 natural 1

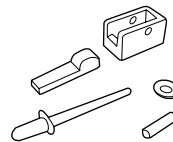

**Individual Dog**  
*Spare for SP511*  
SP512 natural 1

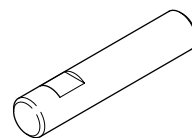

**Dowel for Main Handle**  
SP527 natural 1

**Conveyor Belt Upright**  
SP530 natural 1

# Bill of Materials

## 89 mm standard draw, 2.0 m × 2.0 m

Part code	Description	Qty	Unit	Note
LH503	Headrail,white	1986	mm	
LH651	Tilt shaft	1974	mm	Included with LH503
RH349	Operating chain, plastic	3.6	m	
LH637	Pull cord,white	7.6	m	
LE????	Fabric	53.04	m	
LH627	Stabilising chain	2x26	clips	
LH543	Traveller, std 3A	25	pcs	
LH589	End traveller set	1	pcs	
LH506	Shaft support	1	pcs	
LH507	Expansion grommet	1	pcs	
LH510	Endcap set	1	pcs	
LH513	Distance plate	2	pcs	
LH454	Cord weight	1	pcs	
RH350	Chain connector	1	pcs	
LH609	Louver weight, white	26	pcs	
LH6045	Louver hanger	26	pcs	
LH108	Installation bracket	3 or 4	pcs	

## 89 mm split draw, 2.0 m × 2.0 m

Part code	Description	Qty	Unit	Note
LH503	Headrail,white	1986	mm	
LH651	Tilt shaft	1974	mm	Included with LH503
RH349	Operating chain, plastic	3.6	m	
LH637	Pull cord,white	7.6	m	
LE????	Fabric	57.12	m	
LH627	Stabilising chain	4x14	clips	
LH540	Traveller, std 3C	4	pcs	
LH539	Traveller, std 3D	9	pcs	
LH545	Traveller, rev 3C	4	pcs	
LH544	Traveller, rev 3D	9	pcs	
LH589	End traveller set	2	pcs	
LH508	Shaft support	1	pcs	
LH507	Expansion grommet	1	pcs	
LH510	Endcap set	1	pcs	
LH513	Distance plate	2	pcs	
LH454	Cord weight	1	pcs	
RH350	Chain connector	1	pcs	
LH609	Louver weight, white	28	pcs	
LH6045	Louver hanger	28	pcs	
LH108	Installation bracket	3 or 4	pcs	

**89 mm single draw, Mono Control, 2.0 m × 2.0 m**

<b>Part code</b>	<b>Description</b>	<b>Qty</b>	<b>Unit</b>	<b>Note</b>
LH503	Headrail	1986	mm	
LH651	Tiltshaft	1974	mm	Included with headrail
LH???	Fabric	54.95	m	
LH627	Stabilising chain	2×27	clips	
LH541	Traveller, std 3B	19	pcs	
LH540	Traveller, std 3C	7	pcs	
LH511	Traveller body	1	pcs	without spacer link
LH506	Shaft support	1	pcs	single draw
LH507	Expansion grommet	1	pcs	for shaft support
LH513	Distance plate	2	pcs	
LH517	Mono control endcap set	1	pcs	
LH609	Louver weight	27	pcs	
LH6045	Louver hangers	27	pcs	
LH5182	Control rod, white	1675	mm	1-off
LH5185	Handle	1	pcs	
LH690	Wand gearbox	1	pcs	
LH118	Installation brkts	3 or 4	pcs	

**89 mm split draw, Mono Control, 2.0 m × 2.0 m**

<b>Part code</b>	<b>Description</b>	<b>Qty</b>	<b>Unit</b>	<b>Note</b>
LH503	Headrail	1986	mm	
LH651	Tiltshaft	1974	mm	Included with headrail
LH637	Pull cord	4.3	m	
LH???	Fabric	56.98	m	
LH627	Stabilising chain	4×14	clips	
LH540	Traveller, std 3C	2	pcs	
LH539	Traveller, std 3D	11	pcs	
LH545	Traveller, rev 3C	2	pcs	
LH548	Traveller, rev 3D	11	pcs	
LH511	Traveller body	1	pcs	without spacer link
LH589	End traveller set	1	pcs	
LH513	Distance plate	2	pcs	
LH517	Mono control endcap set	1	pcs	
LH609	Louver weight	28	pcs	
LH6045	Louver hangers	28	pcs	
LH5182	Control rod, white	1675	mm	1-off
LH5185	Handle	1	pcs	
LH690	Wand gearbox	1	pcs	
LH118	Installation brkts	3 or 4	pcs	

# Tooling Guide

The following table shows two possible configurations for users wanting to make Impala vertical blinds. The first list is for customer looking to spend the minimum amount on tooling but may add tools at a latter date. The second list offers a greater range of tools, functions and reduced production times.

## Configurations

	<b>Basic</b>	<b>Advanced</b>
Required	TP103, Rail assembly jig set TP109, Operating chain pliers TP138, Traveller alignment tool TP333B, Impala workstation, 4.0m	TP103, Rail assembly jig set TP109, Operating chain pliers TP138, Traveller alignment tool TP333B, Impala workstation, 4.0m TP148, Components rack TP343, Bench mounted materials dispenser TP341, Shelves, 4.0m long
Optional	TP032, Electric cord cutter	TP032, Electric cord cutter
Optional (vane making)	TP102, Hot melt applicator TP117, Louver fabric clamp TP120, CPC machine TP344, Materials dispenser SP803, Tape measure	TP102, Hot melt applicator TP117, Louver fabric clamp TP120, CPC machine TP344, Materials dispenser SP803, Tape measure
Optional (PVC vanes)	TP131, PVC vane punch (oval) TP135, Corner rounder (PVC vanes)	TP160, PVC/Aquatek bench TP161, PVC vane measuring kit TP162, PVC punch (89mm vanes) TP163, Self standing unit for PVC punch

Many of the tools are composed of other tools, spares, options, etc. The table below shows how tools are related.

<b>Main Tool</b>	<b>Included</b>	<b>Options</b>	<b>Spares</b>
TP032, Electric cord cutter			
TP103, Rail assembly jig set	TP119, Threading needle		
TP109, Operating chain pliers			
(Cut, punch & crease machine)*	TP117, Louver fabric clamp TP120, CPC machine SP522, Fabric dispenser SP803, Tape measure		
TP131, PVC vane punch (oval)			
TP135, Corner rounder (PVC vanes)			
TP138, Traveller alignment tool			
TP160, PVC Aquatek bench		TP161, Vane measuring kit	
TP162, PVC punch (89mm vane)		TP162, Self standing unit	
TP330B, Impala workstation, 4.0m	TP148, Components rack TP343, Free materials disp'r TP343, Bench materials disp'r TP341, Shelves, 4.0m long		

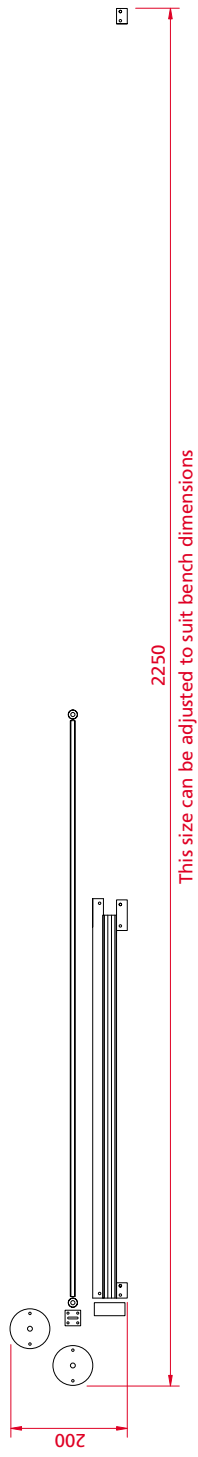

TP103, Rail Assembly Jig Set

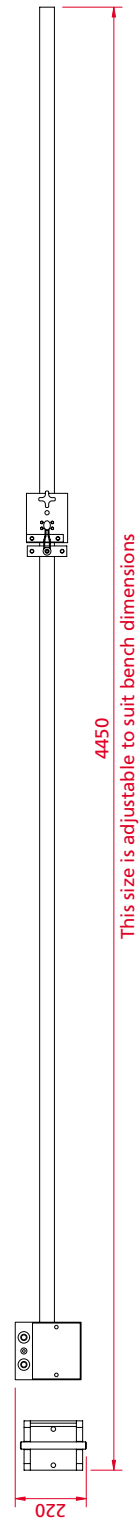

TP117, TP120, SP552 and SP803, CPC Tool

**Impala Vertical Blind**  
Component Book

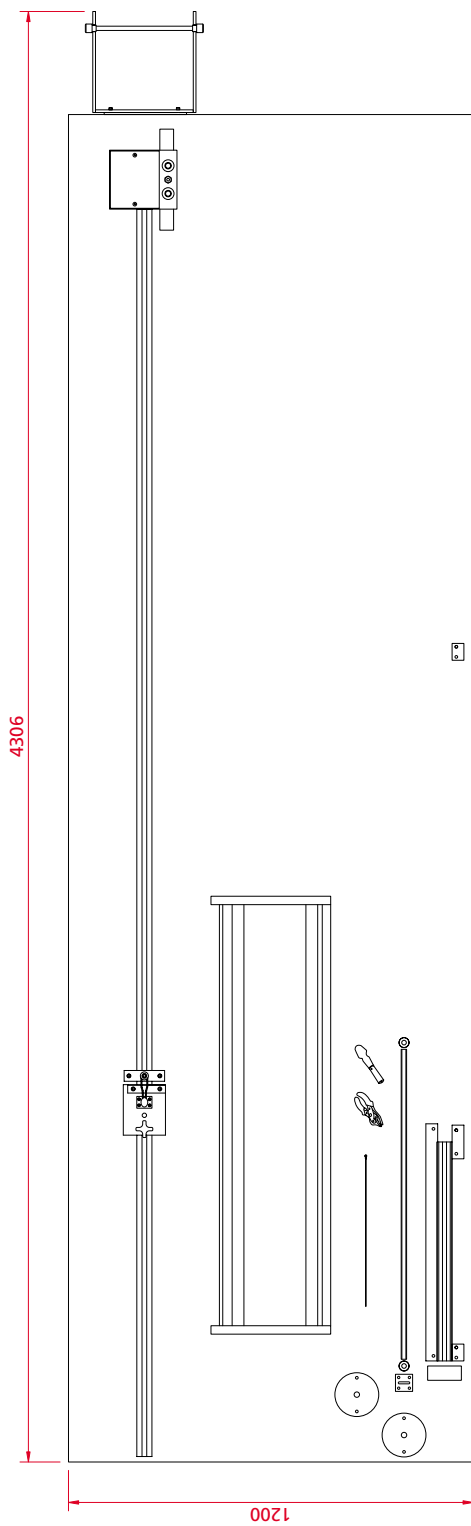

"Advanced" set-up from p27

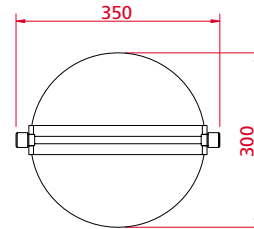

**TP344, Free standing materials dispenser**

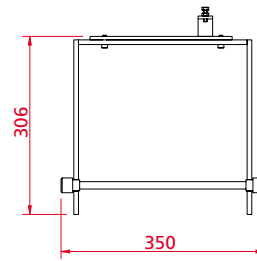

**TP343, Bench mount materials dispenser**

# Index

14233 .....	16	LH454 .....	16	LH591 .....	15	LH807 .....	14
LH077 .....	12	LH501 .....	12	LH592 .....	15	LH809 .....	14
LH078 .....	12	LH502 .....	12	LH593 .....	15	LH825 .....	17
LH101 .....	12	LH503 .....	12	LH594 .....	15	LH827 .....	17
LH103 .....	12	LH506 .....	14	LH595 .....	15	LH890 .....	19
LH106 .....	12	LH507 .....	13	LH596 .....	15	LH901 .....	15
LH108 .....	12	LH508 .....	14	LH597 .....	16	LH902 .....	15
LH109 .....	12	LH509 .....	12	LH598 .....	16	LH903 .....	15
LH111 .....	11	LH510 .....	12	LH602 .....	13	LH904 .....	15
LH113 .....	11	LH511 .....	14	LH6025 .....	13	LH905 .....	15
LH114 .....	11	LH512 .....	13	LH604 .....	13	LH906 .....	15
LH116 .....	11	LH513 .....	13	LH6045 .....	13	LH907 .....	15
LH118 .....	11	LH514 .....	13	LH607 .....	13	LH908 .....	15
LH119 .....	11	LH515 .....	13	LH608 .....	13	LH909 .....	15
LH120 .....	11	LH517 .....	12	LH609 .....	13	LH910 .....	15
LH121 .....	11	LH5182 .....	17	LH610 .....	13	LH911 .....	15
LH122 .....	11	LH5183 .....	18	LH613 .....	14	LH912 .....	15
LH123 .....	12	LH5185 .....	18	LH614 .....	14	LH913 .....	16
LH124 .....	12	LH520 .....	12	LH615 .....	14	LH914 .....	16
LH125 .....	12	LH539 .....	15	LH616 .....	14	LH915 .....	16
LH126 .....	11	LH540 .....	15	LH619 .....	13	LH916 .....	16
LH127 .....	11	LH541 .....	15	LH621 .....	16	LH917 .....	16
LH378 .....	15	LH543 .....	15	LH622 .....	16	LH918 .....	16
LH379 .....	15	LH544 .....	15	LH623 .....	17	LH919 .....	16
LH380 .....	15	LH545 .....	15	LH624 .....	17	LH920 .....	16
LH381 .....	15	LH546 .....	15	LH625 .....	17	LH921 .....	16
LH382 .....	15	LH548 .....	15	LH626 .....	17	LH922 .....	16
LH384 .....	15	LH549 .....	15	LH627 .....	17	LH923 .....	16
LH386 .....	15	LH550 .....	15	LH628 .....	17	LH924 .....	16
LH387 .....	15	LH551 .....	15	LH629 .....	17	MP101 .....	18
LH388 .....	15	LH553 .....	15	LH630 .....	17	MP102 .....	18
LH389 .....	15	LH554 .....	16	LH632 .....	17	MP103 .....	18
LH390 .....	15	LH555 .....	16	LH636 .....	17	MP104 .....	18
LH391 .....	15	LH556 .....	16	LH637 .....	17	MP006 .....	19
LH392 .....	15	LH558 .....	16	LH638 .....	17	MP017 .....	12
LH394 .....	15	LH570 .....	16	LH639 .....	17	MP018 .....	12
LH402 .....	13	LH571 .....	16	LH642 .....	18	MP021 .....	12
LH403 .....	13	LH572 .....	16	LH645 .....	14	MP022 .....	12
LH407 .....	13	LH573 .....	16	LH646 .....	14	MP023 .....	12
LH412 .....	13	LH574 .....	16	LH647 .....	18	MP024 .....	12
LH431 .....	11	LH575 .....	16	LH690 .....	17	MP026 .....	12
LH432 .....	11	LH580 .....	16	LH695 .....	13	MP028 .....	12
LH433 .....	11	LH581 .....	16	LH696 .....	13	MSL135 .....	18
LH438 .....	11	LH582 .....	16	LH740 .....	18	RH349 .....	17
LH439 .....	11	LH583 .....	16	LH746 .....	18	RH350 .....	17
LH451 .....	16	LH584 .....	16	LH749 .....	18		
LH452 .....	16	LH585 .....	16				
LH453 .....	16	LH585 .....	16				
		LH587 .....	14				
		LH589 .....	14				

SP501	23	TP333B	21
SP502	24	TP341	22
SP503	23	TP343	22
SP504	23	TP344	22
SP505	23		
SP506	23	VH640	19
SP507	23	VH645	19
SP508	24		
SP509	24		
SP510	24		
SP511	24		
SP512	24		
SP513	23		
SP514	24		
SP515	24		
SP517	24		
SP518	24		
SP519	24		
SP524	23		
SP525	23		
SP528	24		
SP530	24		
SP531	19		
SP532	19		
SP802	20		
SP803	20		
TP032	20		
TP102	20		
TP103	20		
TP109	20		
TP111	23		
TP112	23		
TP112M	23		
TP117	20		
TP119	20		
TP120	20		
TP131	22		
TP135	22		
TP138	20		
TP140	22		
TP141	22		
TP143	22		
TP148	22		
TP160	21		
TP161	21		
TP162	21		
TP163	21		
TP164	22		
TP166	22		
TP168	20		

# Document History

<b>Issue 8</b> May 2006	Partcodes for cord cleat pack & cord stop ring corrected. Sew-in louver weight exploded diagram added. Brackets LH126/127 added.
<b>Issue 7</b> Jan 2006	Partcodes for clear hanger and clear hook trav body corrected
<b>Issue 6</b> Dec 2005	Clear hanger & hook partcode added, metal louver weight qty added. Name of Sheer Clip corrected, LH517 changed to LH519
<b>Issue 5</b> Oct 2005	Travellers with clear hooks added. Metal louver weight added to p12, Order of parts changed, various tooling changes
<b>Issue 4</b> June 2005	Direct Drive Endcap Set changed to Mono Control Endcap Set on p10. Cobra End Traveller Set added on p12. BOM for split draw, mono control added on p22,

